

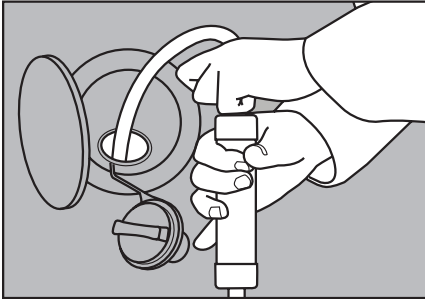

Cleaning the Fuel Tank - Technical Service Bulletin

Step 1: Empty Fuel from Fuel Tank



Drain fuel into approved filtering container or dispose of per local codes or regulations.

Step 5: Remove Fuel Pump Assembly

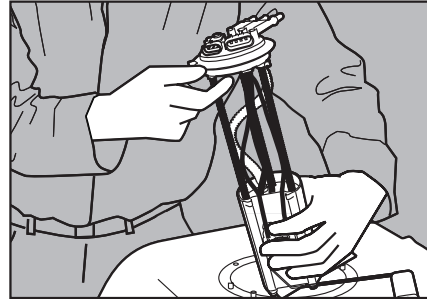

Consult repair manual for proper procedures.

Step 2: Remove Fuel Tank from Vehicle

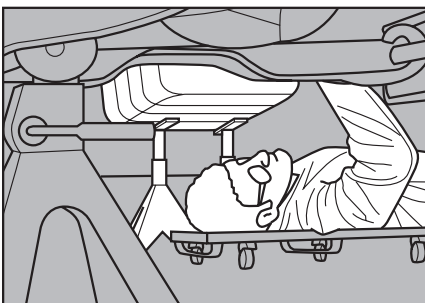

Consult repair manual for proper procedures.

Step 6: Clean Inside of Fuel Tank

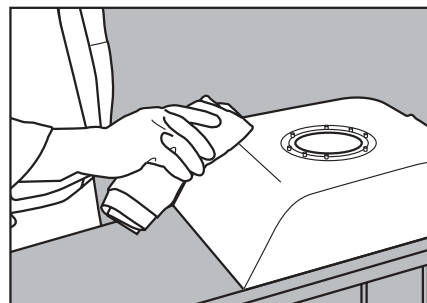

Swirl remaining fuel in circular motion to gather loose contaminants.

Step 3: Clean Outside of Tank

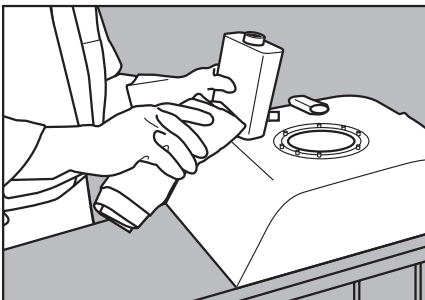

Remove build up and rust from the top of tank, avoiding contamination of inside the fuel tank.

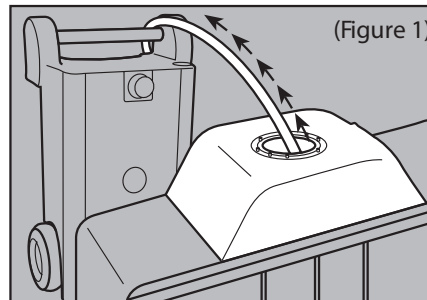

Slowly pour contaminated fuel into approved container and dispose of per local codes or regulations. (Figure 1) Turn over fuel tank and tap to remove remaining contaminants. Clean inside with mild liquid detergent and water.

Step 4: Remove the Lock Ring

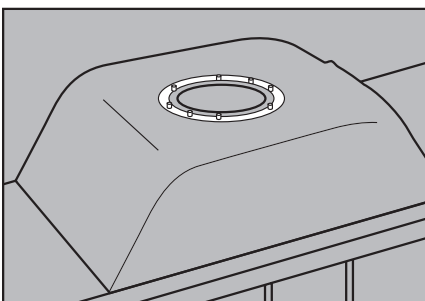

Consult repair manual for proper procedures.

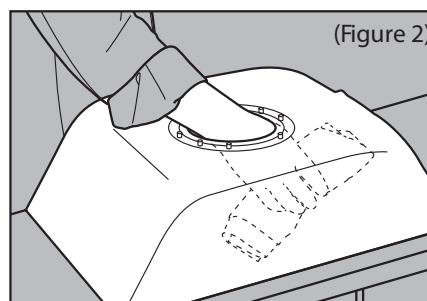

Use a lint-free shop towel to wipe the inside of the fuel tank clean. (Figure 2)



Better Pumps. Better Coverage.

Step 6: Clean Inside of Fuel Tank (continued)

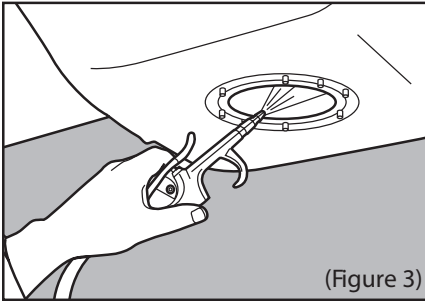

Empty and dry inside of fuel tank with compressed air. (Figure 3)

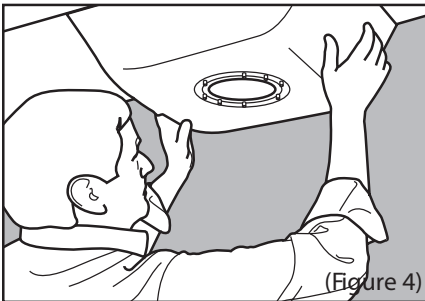

Inspect fuel tank for rust and physical damage. Repair or replace if signs of either. (Figure 4) Allow tank to sit for half hour or until completely dry.

Step 7: Inspect/Replace Vehicle Wiring/Hoses as Needed

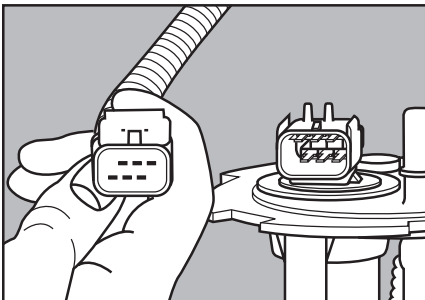

Damaged or faulty vehicle wiring is a leading cause of misdiagnosis and premature fuel pump failure. Wire harness must be replaced if included with new fuel pump. Other replacement harnesses

available for purchase. Replace worn or deteriorated hoses and fittings.

Step 8: Install New Strainer (if required)

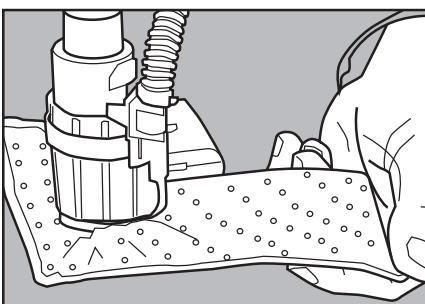

New strainer required to validate warranty.

Step 9: Install New Fuel Pump

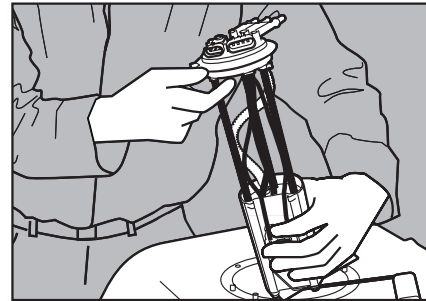

Install new tank seal (if applicable). Consult repair manual for proper installation procedures.

Step 10: Reinstall Fuel Tank

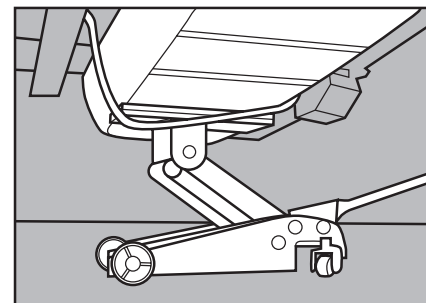

Consult repair manual for proper installation procedures.

Step 11: Replace Vehicle Fuel Filter

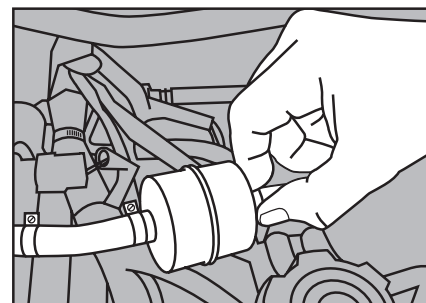

Clogged fuel filter will significantly shorten fuel pump life. Clogged fuel filter may cause low fuel pump pressure.

Step 11: Fill Fuel Tank, Start Engine, and Check for Leaks or Problems

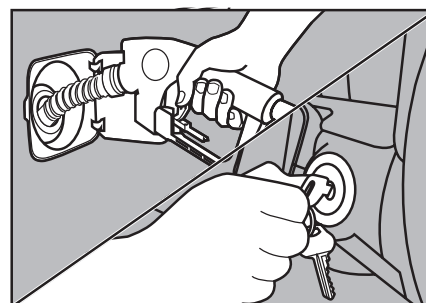

Clean fuel is critical to ensure proper fuel pump operation. All NAPA fuel pumps are tested at point of manufacture to ensure proper operation when installed.

